















EUROPE FILTER 2,5KG 1M (1)

FEATURES

-  This filter is manufactured with fibre-glass and polyester resin.
-  Totally anticorrosive.
-  Fitted with collector arms and diffuser made from unplasticised PVC and polypropilene.
-  Resistent to salted water.
-  Contains newly designed larger and more resistant ABS collector arms.
-  Can be connected to a 4/5 valve battery.
-  Maximum working pressure of 2,5 Kg/cm².

CARACTERÍSTICAS

-  Filtro laminado en fibra de vidrio y poliéster.
-  Totalmente anticorrosivo.
-  Montado con colectores y difusor de material Plástico inalterable PVC y Polipropileno.
-  Resistente al agua salada.
-  Son novedad también los brazos colectores ABS, más resistentes y de mayor tamaño.
-  Posibilidad de acoplarse batería de válvulas.
-  Presión máxima de trabajo 2,5 Kg/cm²

Code	20070	20071	20072	20068	20069	21497	21498	21499
Model (mm)	1050			1200		1400		
Connections (inch)	2"	2 1/2"	3"	2 1/2"	3"	2 1/2"	3"	4"
Filtering velocity (m ³ /h/m ²)	20	30/40	50	20/30	40/50	20	30	40/50
Filtration Area (m ²)	0.86			1.13		1.54		
Flow (m ³ /h)	17	25/34	43	22/33	45/56	30	46	61/77
Maximum pressure (bar)	2.5							
Sand (0.4-0.8mm) (kg)	1050			1350		1850		
Net weight (kg)	115			130		190		
D (mm)	1050			1200		1400		
H (mm)	1860			1860		2000		
M (mm)	270			350		400		
N (mm)	540			570		615		

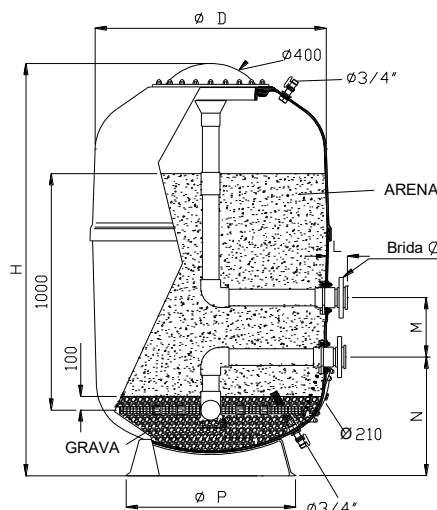







PACKAGING







Code	20070	20071	20072	20068	20069	21497	21498	21499
Model (mm)	1050			1200		1400		
Box dimensions (m)	1.24x1.24x2.05			1.4x1.4x2.05		1.6x1.6x2.14		
Volume (m ³)	3.15			4.01		5.47		

EUROPE FILTER 2,5KG 1M (2)

FEATURES

-  This filter is manufactured with fibre-glass and polyester resin.
-  Totally anticorrosive.
-  Fitted with collector arms and diffuser made from unplasticised PVC and polypropilene.
-  Resistent to salted water.
-  Contains newly designed larger and more resistant ABS collector arms.
-  Can be connected to a 4/5 valve battery.
-  Maximum working pressure of 2,5 Kg/cm².

CARACTERÍSTICAS

-  Filtro laminado en fibra de vidrio y poliéster.
-  Totalmente anticorrosivo.
-  Montado con colectores y difusor de material Plástico inalterable PVC y Polipropileno.
-  Resistente al agua salada.
-  Son novedad también los brazos colectores ABS más resistentes y de mayor tamaño.
-  Posibilidad de acoplarse batería de válvulas.
-  Presión máxima de trabajo 2,5 Kg/cm²

Code	21500	21501	21502	21503	21504	21505	21506
Model (mm)	1600			1800			
Connections (inch)	3"	4"	4 1/2"	3"	4"	4 1/2"	5"
Filtering velocity (m ³ /h/m ²)	20	30/40	50	20	30	40	50
Filtration Area (m ²)	2.01			2.54			
Flow (m ³ /h)	40	60/80	100	50	76	101	125
Maximum pressure (bar)	2.5						
Sand (0.4-0.8mm) (kg)	2375			3010			
Net weight (kg)	225			350			
D (mm)	1600			1800			
H (mm)	2100			2200			
M (mm)				400			
N (mm)	710			725			

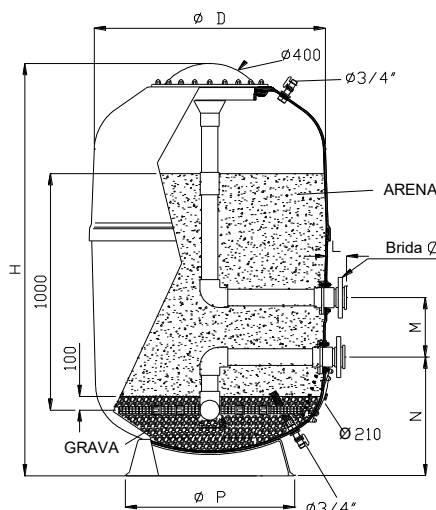

PACKAGING

Code	21500	21501	21502	21503	21504	21505	21506
Model (mm)	1600			1800			
Box dimensions (m)	1.8x1.8x2.22			2x2x2.28			
Volume (m ³)	7.19			9.12			